

Einbaubuchsen und Zubehör

Panel mount jacks and accessories



Einbaubuchsen und Zubehör/ Panel mount jacks and accessories

Inhaltsverzeichnis / contents:

USB Buchse silber	9
<i>USB jack silver</i>	9
USB Buchse Edelstahl	9
<i>USB jack stainless steel</i>	9
USB3.0 Buchse silber	10
<i>USB3.0 jack silver</i>	10
USB3.0 Buchse Edelstahl	10
<i>USB3.0 jack stainless steel</i>	10
USB Buchse silber	11
<i>USB jack silver</i>	11
Doppel USB Buchse silber	11
<i>dual USB jack silver</i>	11
Doppel USB Buchse Edelstahl	12
<i>dual USB jack stainless steel</i>	12
USB A-A Buchse gesteckt	12
<i>USB A-A jack with plugs</i>	12
USB A-A Buchse gesteckt, Edelstahl	13
<i>USB A-A jack with plugs, stainless steel</i>	13
USB3.0 Buchse silber	13
<i>USB3.0 jack silver</i>	13
USB3.0 Buchse, Edelstahl	14
<i>USB3.0 jack, stainless steel</i>	14
USB3.0 Buchse silber	14
<i>USB3.0 jack silver</i>	14
USB3.0 Buchse, Edelstahl	15
<i>USB3.0 jack, stainless steel</i>	15
USB Buchse A-B silber	15
<i>USB jack A-B silver</i>	15

USB Buchse A-B, Edelstahl	16
<i>USB jack A-B, stainless steel</i>	16
USB Buchse B-A silber	16
<i>USB jack B-A silver</i>	16
USB Buchse B-A, Edelstahl	17
<i>USB jack B-A, stainless steel</i>	17
USB Buchse B-B silber	17
<i>USB jack B-B silver</i>	17
USB Buchse B-B, Edelstahl	18
<i>USB jack B-B, stainless steel</i>	18
USB-B Buchse silber	18
<i>USB-B jack silver</i>	18
FireWire-Buchse silber	19
<i>FireWire jack silver</i>	19
FireWire-Buchse, Edelstahl	19
<i>FireWire jack, stainless steel</i>	19
RJ45-Buchse silber	20
<i>RJ45 jack silver</i>	20
RJ45-Buchse, Edelstahl	20
<i>RJ45 jack, stainless steel</i>	20
RJ45-2-Buchsen silber	21
<i>RJ45 2-jacks silver</i>	21
RJ45-2-Buchse, Edelstahl	21
<i>RJ45 2-jacks, stainless steel</i>	21
PS2-Buchsen silber	22
<i>PS2 jacks silver</i>	22
SVHS-Buchse silber	22
<i>SVHS jacks silver</i>	22
HDMI-Buchsen silber	23
<i>HDMI jacks silver</i>	23
2.5mm Klinkenstecker-Buchse silber	23
<i>2.5mm jack plug silver</i>	23

2.5mm Klinkenstecker-Buchse Edelstahl.....	24
<i>2.5mm jack plug, stainless steel</i>	24
3.5mm Klinkenstecker-Buchse silber.....	24
<i>3.5mm jack plug silver</i>	24
3.5mm Klinkenstecker-Buchse Edelstahl.....	25
<i>3.5mm jack plug, stainless steel</i>	25
6.3mm Klinkenstecker-Buchse silber.....	25
<i>6.3mm jack plug silver</i>	25
6.3mm Klinkenstecker-Buchse Edelstahl.....	26
<i>6.3mm jack plug, stainless steel</i>	26
Robuste Schutzkappe aus Aluminium	27
<i>Robust alumium protection cap</i>	27
Plombierbare Schutzkappe.....	27
<i>Lead-sealable protective lid</i>	27
Plombierbare, robuste Schutzkappe	27
<i>Lead-sealable, robust protective lid</i>	27
Schutzkappe aus TPE	28
<i>Protective lid made of TPE</i>	28
LED-Leuchtring für Statusanzeigt oder Illumantion.....	28
<i>LED light ring for status indication or additional illumination</i>	28
Verbindungskabel.....	29
<i>Connection cable</i>	29
RGB-LED-Leuchtring für Statusanzeigt oder Illumantion.....	29
<i>LED light ring for status indication or additional illumination</i>	29
Verbindungskabel zu RGB-LED	29
<i>Connection cable for RGB-LED</i>	29
Montageschlüssel	30
<i>Mounting tool</i>	30
Masse Einbauöffnung.....	30
<i>Cutout dimensions</i>	30

USB-A Buchse silber, abgerundet	31
<i>USB-A jack silver, squarisch</i>	31
USB A-A Buchse Edelstahl, abgerundet	31
<i>USB A-A jack stainless steel, squarisch</i>	31
USB3.0 A-A Buchse silber, abgerundet.....	32
<i>USB3.0 A-A jack silver, squarisch</i>	32
USB A-B Buchse silber, abgerundet	32
<i>USB A-B jack silver, squarisch</i>	32
USB B-A Buchse silber, abgerundet	33
<i>USB B-A jack silver, squarisch</i>	33
USB A-B Buchse silber, abgerundet	33
<i>USB A-B jack silver, squarisch</i>	33
Fire Wire Buchse silber, abgerundet	34
<i>Fire Wire jack silver, squarisch</i>	34
RJ45-Buchse silber, abgerundet	34
<i>RJ45 jack silver, squarisch</i>	34
RJ45-Buchse silber, abgerundet	35
<i>RJ45 jack silver, squarisch</i>	35
Plombierbare Schutzkappe.....	35
<i>Lead-sealable protective lid</i>	35
Plombierbare, robuste Schutzkappe	35
<i>Lead-sealable, robust protective lid</i>	35
Montageschlüssel	36
<i>Mounting tool</i>	36
Masse Einbauöffnung	36
<i>Cutout dimensions</i>	36
USB A Buchse schwarz, quadratisch	37
<i>USB A jack black, square</i>	37
Doppel USB Buchse schwarz, quadratisch.....	37
<i>Dual USB jack black, square</i>	37

USB A-A Buchse schwarz, quadratisch	38
<i>USB A-A jack black, square</i>	38
Schutzkappe, quadratisch.....	38
<i>Protective Lid, square</i>	38
Montageschlüssel	39
<i>Mounting tool</i>	39
Masse Einbauöffnung.....	39
<i>Cutout dimensions</i>	39
VGA Buchse schwarz, rechteckig.....	40
<i>VGA jack black, rectangular</i>	40
Doppel USB Buchse schwarz, rechteckig.....	40
<i>Dual USB jack black, rectangular</i>	40
Montageschlüssel	41
<i>Mounting tool</i>	41
Masse Einbauöffnung.....	41
<i>Cutout dimensions</i>	41

USB-Buchse silber

vorne

- USB-Buchse Typ A

hinten

- USB2.0-Kabel, L=0.6m mit Stecker Typ A

andere Längen auf Anfrage

Frontrahmen silberfarben



Part.nr. EB150001

USB jack silver

front

- USB jack type A

rear

- USB2.0 cable L=0.6m with plug Type A

other length on request

front bezel silver coloured

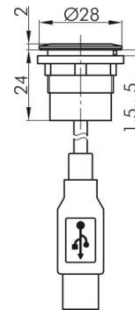

USB-Buchse Edelstahl

vorne

- USB-Buchse Typ A

hinten

- USB2.0-Kabel, L=0.6m mit Stecker Typ A

andere Längen auf Anfrage

Frontrahmen Edelstahl glänzend



Part.nr. EB155001

USB jack stainless steel

front

- USB jack type A

rear

- USB2.0 cable L=0.6m with plug Type A

other length on request

front bezel stainless steel, polished

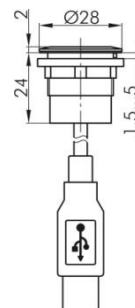

USB3.0 Buchse silber

vorne

- USB-Buchse Typ A

hinten

- USB3.0-Kabel, L=0.6m mit Stecker Typ A

andere Längen auf Anfrage

Frontrahmen silberfarben



Part.nr. EB150002

USB3.0 jack silver

front

- USB jack type A

rear

- USB3.0 cable L=0.6m with plug Type A

other length on request

front bezel silver coloured

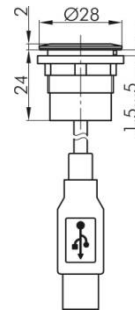

USB3.0 Buchse Edelstahl

vorne

- USB-Buchse Typ A

hinten

- USB3.0-Kabel, L=0.6m mit Stecker Typ A

andere Längen auf Anfrage

Frontrahmen Edelstahl glänzend



Part.nr. EB155001

USB3.0 jack stainless steel

front

- USB jack type A

rear

- USB3.0 cable L=0.6m with plug Type A

other length on request

front bezel stainless steel, polished

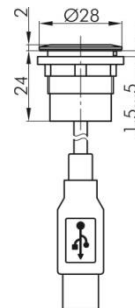

USB Buchse silber

vorne

- USB-Buchse Typ A

hinten

- USB2.0-Kabel, L=1.0m mit Buchsengehäuse 5-polig (Rastermass 2.54mm)

andere Längen auf Anfrage

Frontrahmen silberfarben



Part.nr. EB150003

USB jack silver

front

- USB jack type A

rear

- USB2.0 cable L=1.0m with jacket housing, 5 poles (spacing 2.54mm)

other length on request

front bezel silver coloured

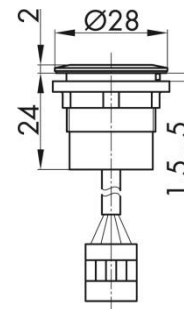

Doppel USB Buchse silber

vorne

- 2x USB-Buchse Typ A

hinten

- 2x USB2.0-Kabel, L=0.6m mit Stecker Typ A

andere Längen auf Anfrage

Frontrahmen silberfarben



Part.nr. EB150004

dual USB jack silver

front

- 2x USB jack type A

rear

- 2x USB2.0 cable L=0.6m with plug Type A

other length on request

front bezel silver coloured

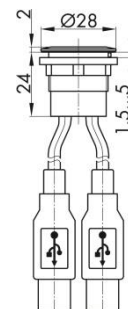

Doppel USB Buchse Edelstahl

vorne

- 2x USB-Buchse Typ A

hinten

- 2x USB2.0-Kabel, L=0.6m mit Stecker Typ A

andere Längen auf Anfrage

Frontrahmen Edelstahl glänzend



Part.nr. EB155004

dual USB jack stainless steel

front

- 2x USB jack type A

rear

- 2x USB2.0 cable L=0.6m with plug Type A

other length on request

front bezel stainless steel, polished

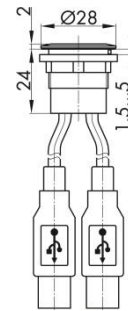

USB A-A Buchse gesteckt

vorne

- USB-Buchse Typ A

hinten

- USB-Buchse Typ A

Frontrahmen silberfarben



Part.nr. EB150005

USB A-A jack with plugs

front

- USB jack type A

rear

- USB jack Type A

front bezel silver coloured

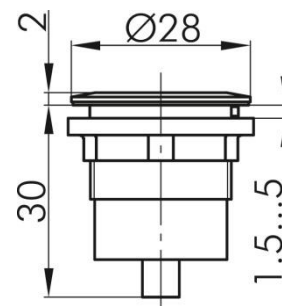

USB A-A Buchse gesteckt, Edelstahl

vorne

- USB-Buchse Typ A

hinten

- USB-Buchse Typ A

Frontrahmen Edelstahl glänzend



Part.nr. EB155005

USB A-A jack with plugs, stainless steel

front

- USB jack type A

rear

- USB jack Type A

front bezel stainless steel, polished

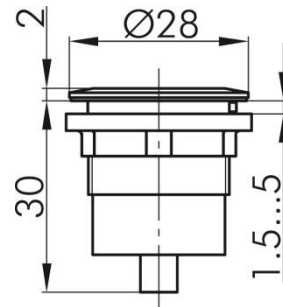

USB3.0 Buchse silber

vorne

- USB-Buchse Typ A, Pinning 1:1

hinten

- USB-Buchse Typ A

Frontrahmen silberfarben



Part.nr. EB150006

USB3.0 jack silver

front

- USB jack type A, pinning 1:1

rear

- USB2.0 cable L=0.6m with plug Type A

other length on request

front bezel silver coloured

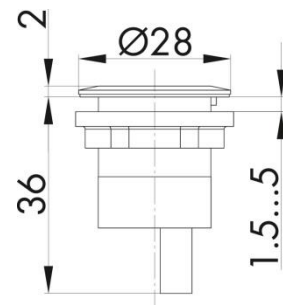

USB3.0 Buchse, Edelstahl

vorne

- USB-Buchse Typ A, Pinning 1:1

hinten

- USB-Buchse Typ A

Frontrahmen Edelstahl glänzend



Part.nr. EB155006

USB3.0 jack, stainless steel

front

- USB jack type A, pinning 1:1

rear

- USB jack Type A

front bezel stainless steel, polished

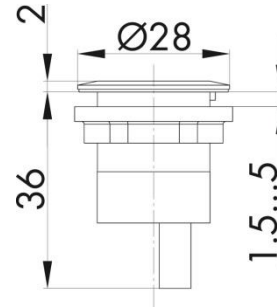

USB3.0 Buchse silber

vorne

- USB-Buchse Typ A,

hinten

- USB-Buchse Typ A

Frontrahmen silberfarben



Part.nr. EB150007

USB3.0 jack silver

front

- USB jack type A,

rear

- USB jack Type A

front bezel silver coloured

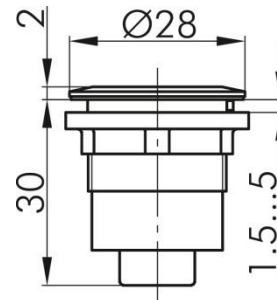

USB3.0 Buchse, Edelstahl

vorne

- USB-Buchse Typ A,

hinten

- USB-Buchse Typ A

Frontrahmen Edelstahl glänzend



Part.nr. EB155007

USB3.0 jack, stainless steel

front

- USB jack type A,

rear

- USB jack Type A

front bezel stainless steel, polished

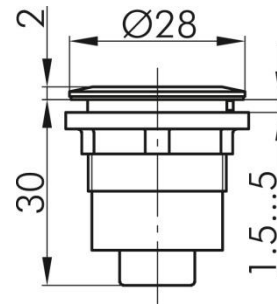

USB A-B Buchse silber

vorne

- USB-Buchse Typ A,
- gedrehte Datenleitung

hinten

- USB-Buchse Typ B

Frontrahmen silberfarben



Part.nr. EB150008

USB A-B jack silver

front

- USB jack type A,
- twisted data line

rear

- USB jack Type B

front bezel silver coloured

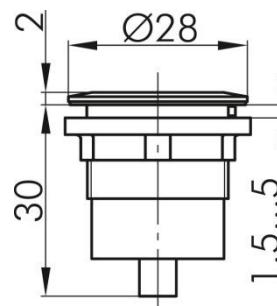

USB A-B Buchse, Edelstahl

vorne

- USB-Buchse Typ A

hinten

- USB-Buchse Typ B

Frontrahmen Edelstahl glänzend



Part.nr. EB155008

USB A-B jack, stainless steel

front

- USB jack type A

rear

- USB jack Type B

front bezel stainless steel, polished

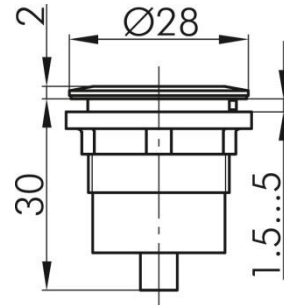

USB B-A Buchse silber

vorne

- USB-Buchse Typ B

hinten

- USB-Buchse Typ A

Frontrahmen silberfarben



Part.nr. EB150010

USB B-A jack silver

front

- USB jack type B

rear

- USB jack Type A

front bezel silver coloured

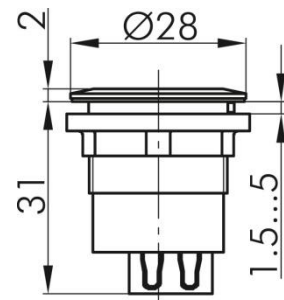

USB B-A Buchse, Edelstahl

vorne

- USB-Buchse Typ B

hinten

- USB-Buchse Typ A

Frontrahmen Edelstahl glänzend



Part.nr. EB155010

USB B-A jack, stainless steel

front

- USB jack type B

rear

- USB jack Type A

front bezel stainless steel, polished

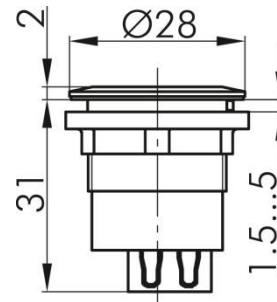

USB B-B Buchse silber

vorne

- USB-Buchse Typ B

hinten

- USB-Buchse Typ B

Frontrahmen silberfarben



Part.nr. EB150011

USB B-B jack silver

front

- USB jack type B

rear

- USB jack Type B

front bezel silver coloured

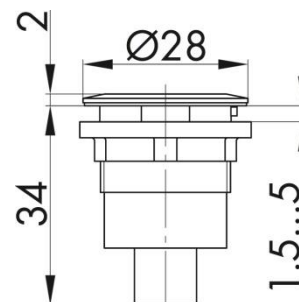

USB Buchse B-B, Edelstahl

vorne

- USB-Buchse Typ B

hinten

- USB-Buchse Typ B

Frontrahmen Edelstahl glänzend



Part.nr. EB155011

USB jack B-B, stainless steel

front

- USB jack type B

rear

- USB jack Type B

front bezel stainless steel, polished

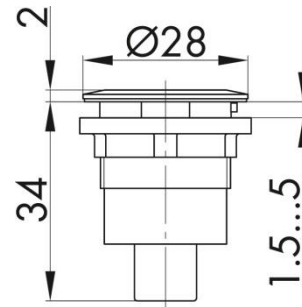

USB-B Buchse silber

vorne

- USB-Buchse Typ B

hinten

- USB2.0-Kabel, L=0.5m mit Stecker Typ B

andere Längen auf Anfrage

Frontrahmen silberfarben



Part.nr. EB150012

USB-B jack silver

front

- USB jack type B

rear

- USB2.0 cable L=0.5m with plug Type B

other length on request

front bezel silver coloured

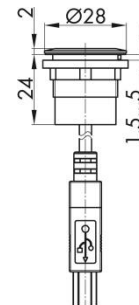

FireWire-Buchse silber

vorne

- FireWire-Buchse

hinten

- FireWire-Buchse

Frontrahmen silberfarben



Part.nr. EB150013

FireWire jack silver

front

- FireWire jack

rear

- FireWire jack

front bezel silver coloured

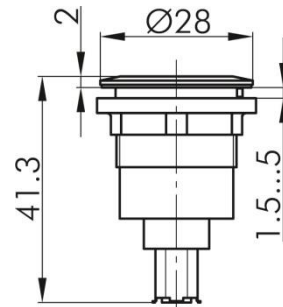

FireWire-Buchse, Edelstahl

vorne

- FireWire-Buchse

hinten

- FireWire-Buchse

Frontrahmen Edelstahl glänzend



Part.nr. EB155013

FireWire jack, stainless steel

front

- FireWire jack

rear

- FireWire jack

front bezel stainless steel, polished

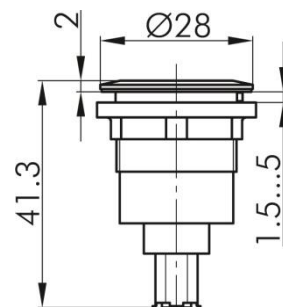

RJ45-Buchse silber

vorne

- RJ45-Buchse geschirmt

hinten

- Patchkabel RJ45 geschirmt, L=0.6m

Frontrahmen silberfarben



Part.nr. EB150014

RJ45 jack silver

front

- RJ45 jack, shielded

rear

- patch cord RJ45, shielded, L=0.6m

front bezel silver coloured

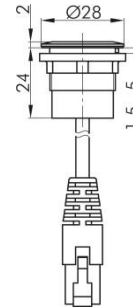

RJ45-Buchse, Edelstahl

vorne

- RJ45-Buchse geschirmt

hinten

- Patchkabel RJ45 geschirmt, L=0.6m

Frontrahmen Edelstahl glänzend



Part.nr. EB155014

RJ45 jack, stainless steel

front

- RJ45 jack, shielded

rear

- patch cord RJ45, shielded, L=0.6m

front bezel stainless steel, polished

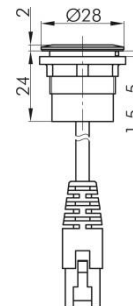

RJ45-2-Buchsen silber

vorne

- RJ45-Buchse geschirmt

hinten

- RJ45-Buchse geschirmt

Frontrahmen silberfarben



Part.nr. EB150015

RJ45 2-jacks silver

front

- RJ45 jack, shielded

rear

- RJ45 jack, shielded

front bezel silver coloured

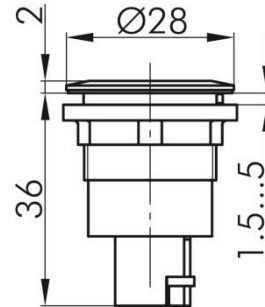

RJ45-2-Buchse, Edelstahl

vorne

- RJ45-Buchse geschirmt

hinten

- RJ45-Buchse geschirmt

Frontrahmen Edelstahl glänzend



Part.nr. EB155015

RJ45 2-jacks, stainless steel

front

- RJ45 jack, shielded

rear

- RJ45 jack, shielded

front bezel stainless steel, polished

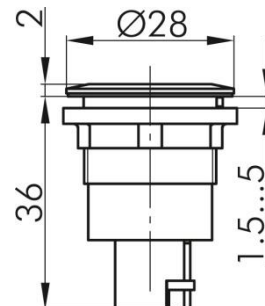

PS2-Buchsen silber

vorne

- PS2-Buchse

hinten

- PS2 – Kabel (L=2.0m) mit PS2 – Stecker

Frontrahmen Edelstahl glänzend



Part.nr. EB150016

PS2 jacks silver

front

- PS2 jack

rear

- PS2 cable (L=2.0m) with PS2 plug

front bezel stainless steel, polished

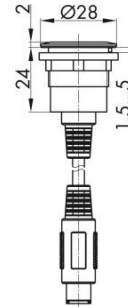

SVHS-Buchse silber

vorne

- SVHS-Buchse

hinten

- SVHS – Kabel (L=2.0m) mit SVHS – Stecker

Frontrahmen silberfarben



Part.nr. EB150017

SVHS jacks silver

front

- SVHS jack

rear

- SVHS cable (L=2.0m) with SVHS plug

front bezel silver coloured

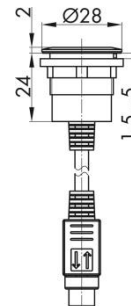

HDMI-Buchsen silber

vorne

- HDMI-Buchse

hinten

- HDMI-Buchse

Frontrahmen silberfarben



Part.nr. EB150018

HDMI jacks silver

front

- HDMI jack

rear

- HDMI jack

front bezel silver coloured

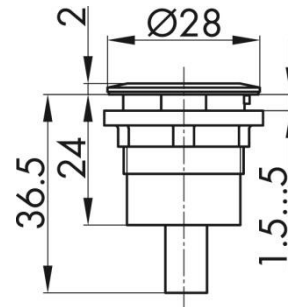

2.5mm Klinkenstecker-Buchse silber

vorne

- 2.5mm Klinkenstecker-Buchse 3polig

hinten

- Kabel (L=2.0m) mit 2.5mm Klinkenstecker

andere Längen auf Anfrage

Frontrahmen silberfarben



Part.nr. EB150019

2.5mm jack plug silver

front

- 2.5mm jack socket (TRS) jack

rear

- cable (L=2.0m) with 2.5mm jack plug

other length on request

front bezel silver coloured

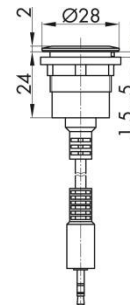

2.5mm Klinkenstecker-Buchse Edelstahl

vorne

- 2.5mm Klinkenstecker-Buchse 3polig

hinten

- Kabel (L=2.0m) mit 2.5mm Klinkenstecker

andere Längen auf Anfrage

Frontrahmen Edelstahl glänzend



Part.nr. EB155019

2.5mm jack plug, stainless steel

front

- 2.5mm jack socket (TRS) jack

rear

- cable (L=2.0m) with 2.5mm jack plug

other length on request

front bezel stainless steel, polished

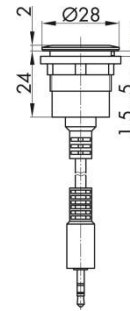

3.5mm Klinkenstecker-Buchse silber

vorne

- 3.5mm Klinkenstecker-Buchse 3polig

hinten

- Kabel (L=2.0m) mit 3.5mm Klinkenstecker

andere Längen auf Anfrage

Frontrahmen silberfarben



Part.nr. EB150020

3.5mm jack plug silver

front

- 3.5mm jack socket (TRS) jack

rear

- cable (L=2.0m) with 3.5mm jack plug

other length on request

front bezel silver coloured

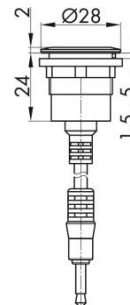

3.5mm Klinkenstecker-Buchse Edelstahl

vorne

- 3.5mm Klinkenstecker-Buchse 3polig

hinten

- Kabel (L=2.0m) mit 3.5mm Klinkenstecker

andere Längen auf Anfrage

Frontrahmen Edelstahl glänzend



Part.nr. EB150020

3.5mm jack plug, stainless steel

front

- 3.5mm jack socket (TRS) jack

rear

- cable (L=2.0m) with 3.5mm jack plug

other length on request

front bezel stainless steel, polished

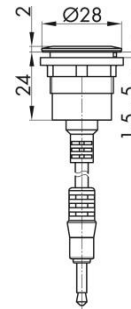

6.3mm Klinkenstecker-Buchse silber

vorne

- 6.3mm Klinkenstecker-Buchse 3polig

hinten

- Kabel (L=2.0m) mit 6.3mm Klinkenstecker

andere Längen auf Anfrage

Frontrahmen silberfarben



Part.nr. EB150021

6.3mm jack plug silver

front

- 3.5mm jack socket (TRS) jack

rear

- cable (L=2.0m) with 6.3mm jack plug

other length on request

front bezel silver coloured

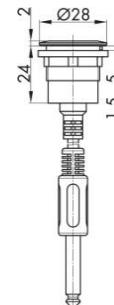

6.3mm Klinkenstecker-Buchse Edelstahl

vorne

- 6.3mm Klinkenstecker-Buchse 3polig

hinten

- Kabel (L=2.0m) mit 6.3mm Klinkenstecker

andere Längen auf Anfrage

Frontrahmen Edelstahl glänzend



Part.nr. EB150021

6.3mm jack plug, stainless steel

front

- 6.3mm jack socket (TRS) jack

rear

- cable (L=2.0m) with 6.3mm jack plug

other length on request

front bezel stainless steel, polished

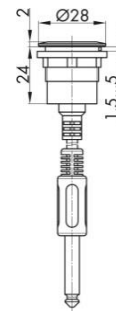

Robuste Schutzkappe aus Aluminium

Deckel verliersicher, schraubbar
passend für alle Buchsen der Baureihe "rund"

Farbe: silber



Robust aluminium protection cap

*Captive lid, threadable
suitable for all round jack*

Colour: silver coloured

Part.nr. EB150500

Plombierbare Schutzkappe

Von -30° bis +70°C

Farbe: transparent



Lead-sealable protective lid

From -30°C to +70°C

Colour: transparent

Part.nr. EB150501

Plombierbare, robuste Schutzkappe

Von -30° bis +70°C

Farbe: transparent



Lead-sealable, robust protective lid

From -30°C to +70°C

Colour: transparent

Part.nr. EB150502

Schutzkappe aus TPE

Von -50° bis +100°C

Farbe: schwarz



Protective lid made of TPE

From -50°C to +100°C

Colour: black

Part.nr. EB150503

LED-Leuchtring für Statusanzeigt oder Illumination

- für ein zusätzliches Leuchtsignal
- Nennspannung 24V AC/DC
- Nennstrom: 25 ... 35ma (DC)
- Ø 30.5mm Einbauöffnung
- Anschluss: für JST-Stecker ZHR-3

Lieferung ohne Betätiger

Farbe der LED blau
 gelb
 weiss
 rot
 grün



LED light ring for status indication or additional illumination

- for an additional light signal
- rated voltage: 24V AC/DC
- rated current: 25 ... 35mA (DC)
- 30.5mm mounting aperture
- connection: for JST plug ZHR-3

Delivery without actuator

LED colour blue
 yellow
 white
 red
 green

Part.nr. EB150050

Verbindungskabel

Mit offenem Ende, zum Anschluss der LED-Leuchtringe an eine Spannungsquelle

Länge: ca. 0.8m, Querschnitt 0.14mm²



RGB-LED-Leuchtring für Statusanzeigt oder Illumination

- für ein zusätzliches Leuchtsignal
- einteiliger Ring (360°)
- Nennspannung 24V AC/DC
- eine von bis zu 16.7 Mio Farben darstellbar (PWM)
- Anschluss: für JST-Stecker ZHR-3

Farbe der LED	blau
	rot
	grün



Verbindungskabel zu RGB-LED

Mit offenem Ende, zum Anschluss der RGB-LED-Leuchtringe an eine Spannungsquelle

Länge: ca. 0.8m, Querschnitt 0.14mm²



Connection cable

With open end, to connect the LED light ring to a power supply

Length: approx. 0.8m, cross section 0.14mm²

Part.nr. EB150600

LED light ring for status indication or additional illumination

- *for an additional light signal*
- *rated voltage: 24V AC/DC*
- *up to 16.7 Mio colours are possible (mix with PWM)*
- *connection: for JST plug ZHR-3*

LED colour	blue
	red
	green

Part.nr. EB150051

Connection cable for RGB-LED

With open end, to connect the RGB LED light ring to a power supply

Length: approx. 0.8m, cross section 0.14mm²

Part.nr. EB150602

Montageschlüssel

Sechskant mit Drehmomentbegrenzung für alle runden Bauformen

Mounting tool

With torque limitation for all round shaped jacks



Part.nr. EB150601

Masse Einbauöffnung

Cutout dimensions

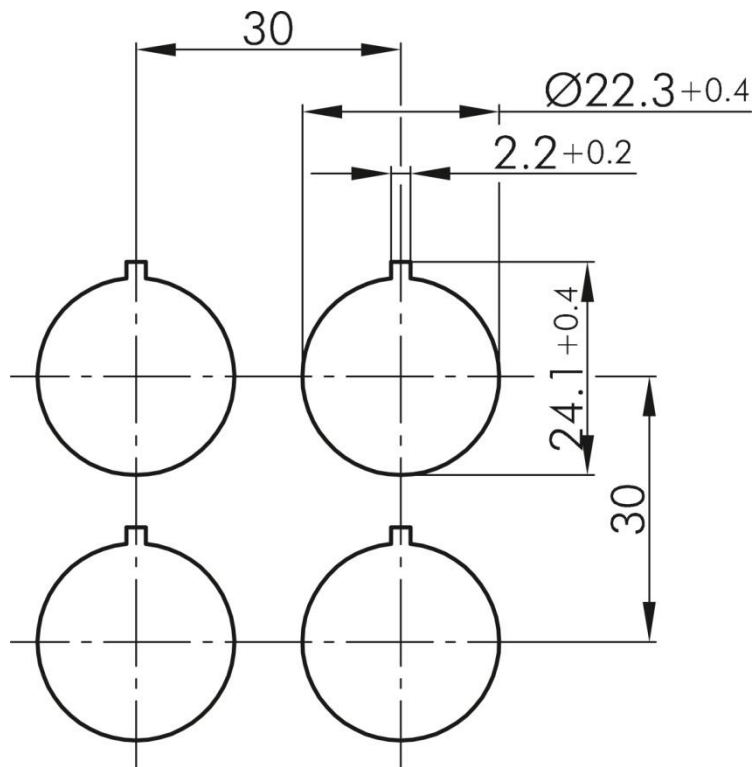

USB-A Buchse silber, abgerundet

vorne

- USB-Buchse Typ A

hinten

- USB2.0-Kabel, L=0.6m mit Stecker Typ A

andere Längen auf Anfrage

Frontrahmen silberfarben



Part.nr. EB150100

USB-A jack silver, squarisch

front

- USB jack type A

rear

- USB2.0 cable L=0.6m with plug Type A

other length on request

front bezel silver coloured

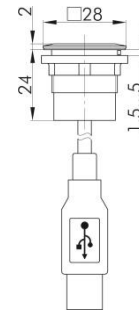

USB A-A Buchse Edelstahl, abgerundet

vorne

- USB-Buchse Typ A

hinten

- USB-Buchse Typ A

Frontrahmen Edelstahl glänzend



Part.nr. EB150101

USB A-A jack stainless steel, squarisch

front

- USB jack type A

rear

- USB jack type A

front bezel stainless steel, polished

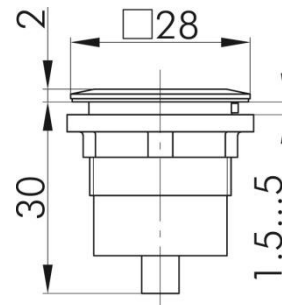

USB3.0 A-A Buchse silber, abgerundet

vorne

- USB-Buchse Typ A

hinten

- USB-Buchse Typ A

Frontrahmen silberfarben



Part.nr. EB150102

USB3.0 A-A jack silver, squarisch

front

- USB jack type A

rear

- USB jack type A

front bezel silver coloured

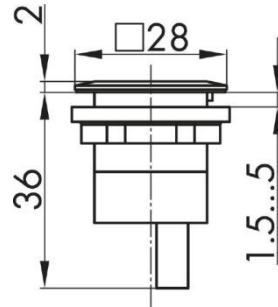

USB A-B Buchse silber, abgerundet

vorne

- USB-Buchse Typ A

hinten

- USB-Buchse Typ B

Frontrahmen silberfarben



Part.nr. EB150104

USB A-B jack silver, squarisch

front

- USB jack type A

rear

- USB3 USB jack type B

front bezel silver coloured

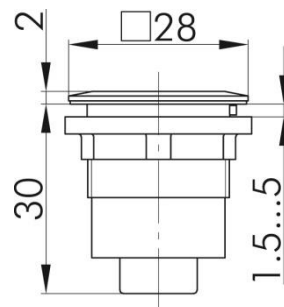

USB B-A Buchse silber, abgerundet

vorne

- USB-Buchse Typ B

hinten

- USB-Buchse Typ A

Frontrahmen silberfarben



Part.nr. EB150105

USB B-A jack silver, squarisch

front

- USB jack type B

rear

- USB jack type A

front bezel silver coloured

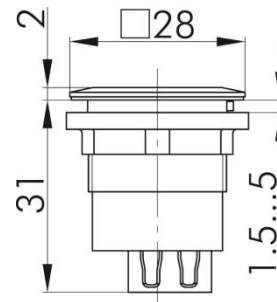

USB B-B Buchse silber, abgerundet

vorne

- USB-Buchse Typ B

hinten

- USB-Buchse Typ B

Frontrahmen silberfarben



Part.nr. EB150106

USB B-B jack silver, squarisch

front

- USB jack type B

rear

- USB3 USB jack type B

front bezel silver coloured

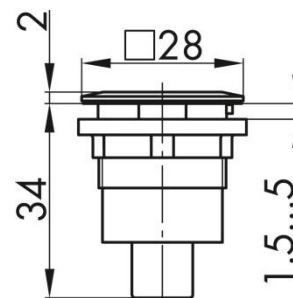

Fire Wire Buchse silber, abgerundet

vorne

- Fire-Wire-Buchse

hinten

- Fire-Wire-Buchse

Frontrahmen silberfarben



Part.nr. EB150107

Fire Wire jack silver, squarisch

front

- Fire Wire jack

rear

- Fire Wire jack

front bezel silver coloured

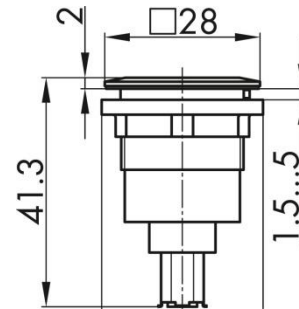

RJ45-Buchse silber, abgerundet

vorne

- RJ45-Buchse geschirmt

hinten

- Patchkabel RJ45 geschirmt, L=0.6m

Frontrahmen silberfarben



Part.nr. EB150108

RJ45 jack silver, squarisch

front

- RJ45 jack shielded

rear

- patch cord RJ45 shielded, L=0.6m

front bezel silver coloured

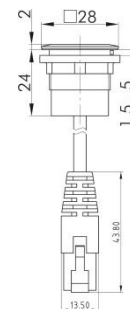

RJ45-Buchse silber, abgerundet

vorne

- RJ45-Buchse geschirmt

hinten

- RJ45-Buchse geschirmt

Frontrahmen silberfarben



Part.nr. EB150100

RJ45 jack silver, squarisch

front

- RJ45 jack shielded

rear

- RJ45 jack shielded

front bezel silver coloured

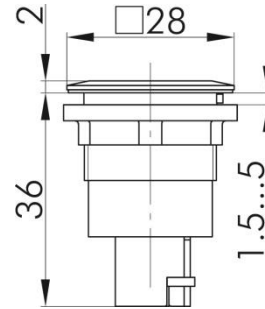

Plombierbare Schutzkappe

Von -30° bis +70°C

Farbe: transparent



Part.nr. EB150501

Lead-sealable protective lid

From -30°C to +70°C

Colour: transparent

Plombierbare, robuste Schutzkappe

Von -30° bis +70°C

Farbe: transparent



Part.nr. EB150502

Lead-sealable, robust protective lid

From -30°C to +70°C

Colour: transparent

Montageschlüssel

Sechskant mit Drehmomentbegrenzung für alle runden Bauformen

Mounting tool

With torque limitation for all round shaped jacks



Part.nr. EB150601

Masse Einbauöffnung

Cutout dimensions

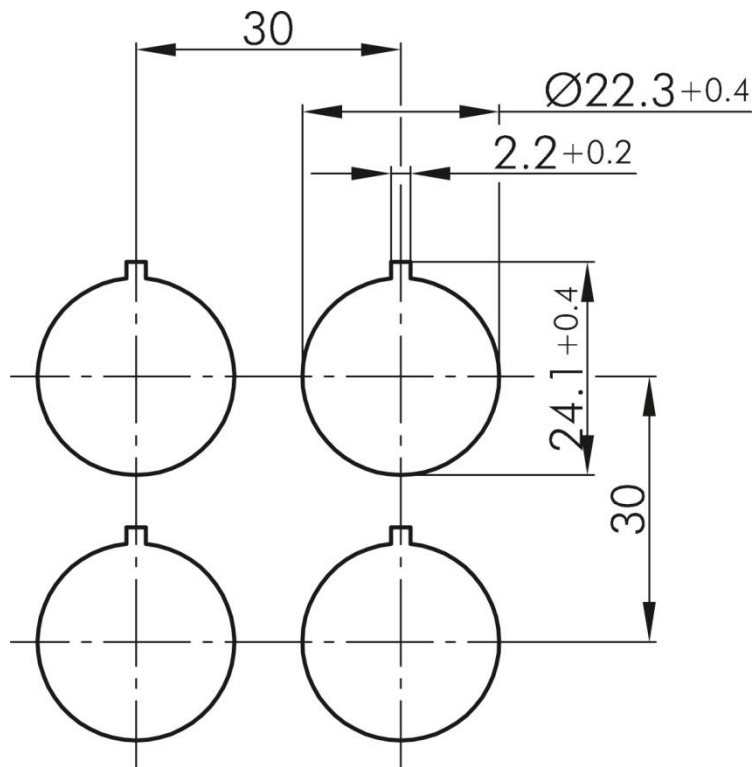

USB A Buchse schwarz, quadratisch

vorne

- USB-Buchse Typ A

hinten

- USB2.0-Kabel (L=0.6m) mit Stecker Typ A

Frontrahmen schwarz



Part.nr. EB150200

USB A jack black, square

front

- USB jack type A

rear

- USB2.0 cable L=0.6m with plug Type A

front bezel black coloured

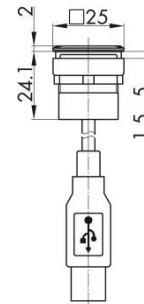

Doppel USB Buchse schwarz, quadratisch

vorne

- 2x USB-Buchse Typ A

hinten

- 2x USB2.0-Kabel (L=0.6m) mit Stecker Typ A

Frontrahmen schwarz



Part.nr. EB150201

Dual USB jack black, square

front

- 2x USB jack type A

rear

- 2x USB2.0 cable L=0.6m with plug Type A

front bezel black coloured

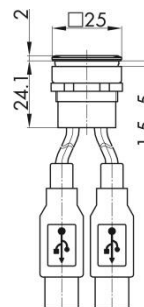

USB A-A Buchse schwarz, quadratisch

vorne

- USB-Buchse Typ A

hinten

- USB-Buchse Typ A

Frontrahmen schwarz



Part.nr. EB150603

USB A-A jack black, square

front

- USB jack type A

rear

- USB jack type A

front bezel black coloured

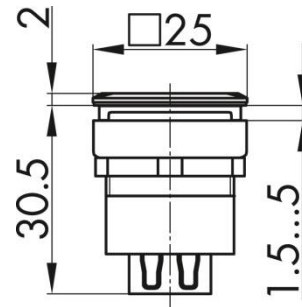

Schutzkappe, quadratisch

vorne

- Für Drucktasten rechteckig

Farbe transparent



Part.nr. EB150604

Protective Lid, square

front

- for pushbuttons rectangular

colour transparent

Montageschlüssel

Sechskant mit Drehmomentbegrenzung für alle runden Bauformen

Mounting tool

With torque limitation for all round shaped jacks



Part.nr. EB150601

Masse Einbauöffnung

Cutout dimensions

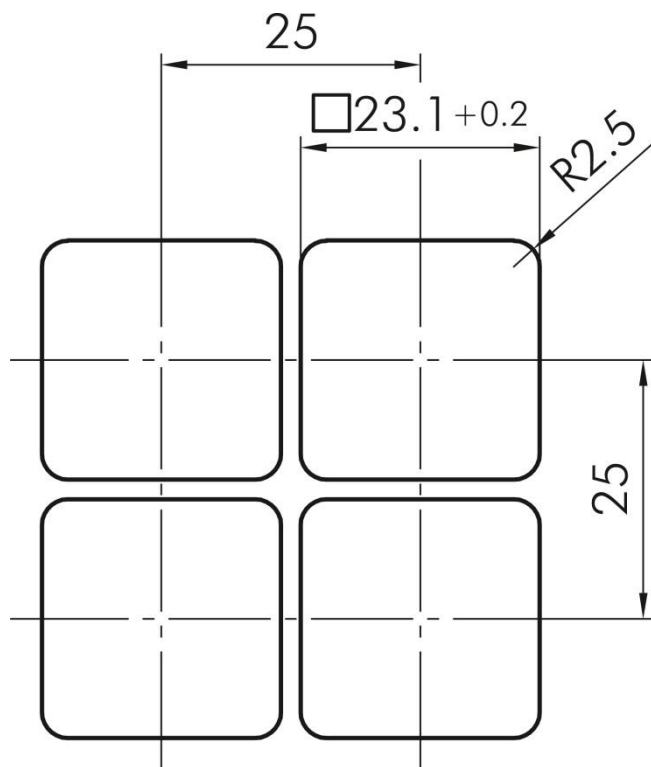

VGA Buchse schwarz, rechteckig

vorne

- VGA-Buchse

hinten

- VGA-Kabel (L=1.0m) mit Stecker

andere Längen auf Anfrage

Frontrahmen schwarz



Part.nr. EB150300

VGA jack black, rectangular

front

- VGA jack

rear

- VGA cable L=1.0m with plug

other length on request

front bezel black coloured

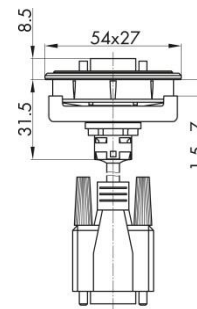

Doppel USB Buchse schwarz, rechteckig

vorne

- RS232-Buchse (D-Sub 9pol)

hinten

- RS232-Kabel D-Sub(L=1.0m) mit Stecker

andere Längen auf Anfrage

Frontrahmen schwarz



Part.nr. EB150302

Dual USB jack black, rectangular

front

- 2x USB jack type A

rear

- 2x USB2.0 cable L=0.6m with plug Type A

other length on request

front bezel black coloured

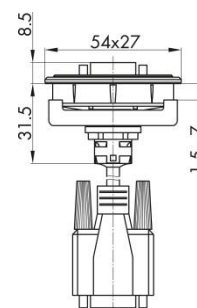

Montageschlüssel

Sechskant mit Drehmomentbegrenzung für alle runden Bauformen

Mounting tool

With torque limitation for all round shaped jacks



Part.nr. EB150603

Masse Einbauöffnung

Cutout dimensions

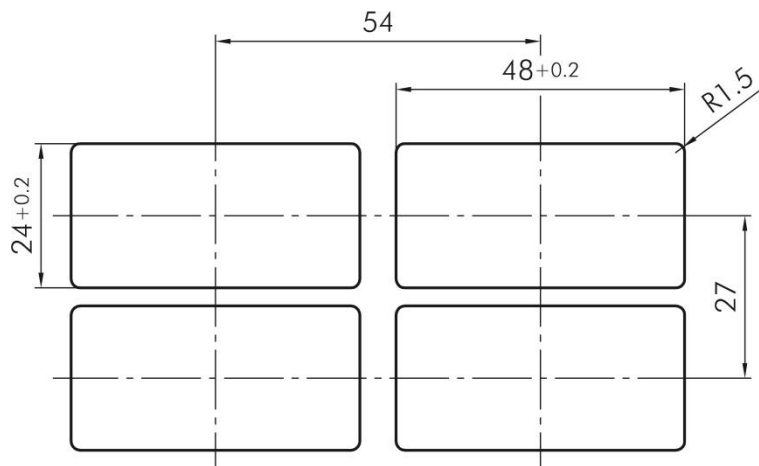

**KOCH Kabel**
Smart cabling by Koch Kabel AG

Koch Kabel AG
Sagenstrasse 2
CH-6252 Dagmersellen

T: +41 (62) 748 49 00
F: +41 (62) 748 49 01

E: contact@kochkabel.ch

H: www.kochkabel.ch